

MDR8

Maximum Dynamic Range

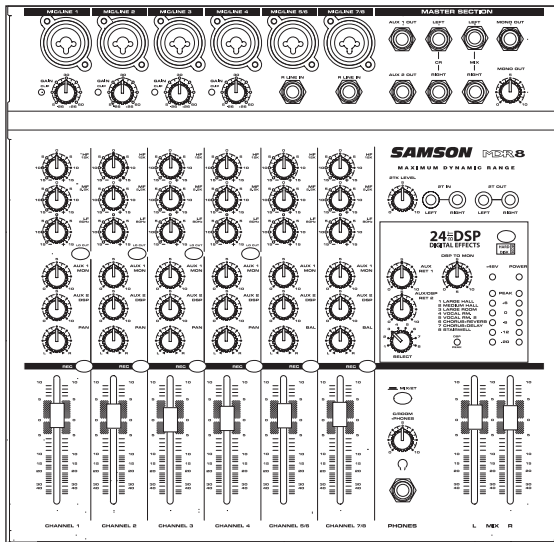

**EIGHT CHANNEL MIXER
WITH 24BIT DIGITAL EFFECTS
AND HARD DISK MODE**

Owners Manual

2

Safety Instructions/Consignes de sécurité/Sicherheitsvorkehrungen/Instrucciones de seguridad



WARNING: To reduce the risk of fire or electric shock, do not expose this unit to rain or moisture. To reduce the hazard of electrical shock, do not remove cover or back. No user serviceable parts inside. Please refer all servicing to qualified personnel. The lightning flash with an arrowhead symbol within an equilateral triangle, is intended to alert the user to the presence of uninsulated "dangerous voltage" within the products enclosure that may be of sufficient magnitude to constitute a risk of electric shock to persons. The exclamation point within an equilateral triangle is intended to alert the user to the presence of important operating and maintenance (servicing) instructions in the literature accompanying the product.

Important Safety Instructions

1. Please read all instructions before operating the unit.
2. Keep these instructions for future reference.
3. Please heed all safety warnings.
4. Follow manufacturers instructions.
5. Do not use this unit near water or moisture.
6. Clean only with a damp cloth.
7. Do not block any of the ventilation openings. Install in accordance with the manufacturers instructions.
8. Do not install near any heat sources such as radiators, heat registers, stoves, or other apparatus (including amplifiers) that produce heat.
9. Do not defeat the safety purpose of the polarized or grounding-type plug. A polarized plug has two blades with one wider than the other. A grounding type plug has two blades and a third grounding prong. The wide blade or third prong is provided for your safety. When the provided plug does not fit your outlet, consult an electrician for replacement of the obsolete outlet.
10. Protect the power cord from being walked on and pinched particularly at plugs, convenience receptacles and at the point at which they exit from the unit.
11. Unplug this unit during lightning storms or when unused for long periods of time.
12. Refer all servicing to qualified personnel. Servicing is required when the unit has been damaged in any way, such as power supply cord or plug damage, or if liquid has been spilled or objects have fallen into the unit, the unit has been exposed to rain or moisture, does not operate normally, or has been dropped.

ACHTUNG: Um die Gefahr eines Brandes oder Stromschlags zu verringern, sollten Sie dieses Gerät weder Regen noch Feuchtigkeit aussetzen. Um die Gefahr eines Stromschlags zu verringern, sollten Sie weder Deckel noch Rückwand des Geräts entfernen. Im Innern befinden sich keine Teile, die vom Anwender gewartet werden können. Überlassen Sie die Wartung qualifiziertem Fachpersonal. Der Blitz mit Pfeilspitze im gleichseitigen Dreieck soll den Anwender vor nichtisolierter "gefährlicher Spannung" im Geräterinnern warnen. Diese Spannung kann so hoch sein, dass die Gefahr eines Stromschlags besteht. Das Ausrufezeichen im gleichseitigen Dreieck soll den Anwender auf wichtige Bedienungs- und Wartungsanleitungen aufmerksam machen, die im mitgelieferten Informationsmaterial näher beschrieben werden.

Wichtige Sicherheitsvorkehrungen

1. Lesen Sie alle Anleitungen, bevor Sie das Gerät in Betrieb nehmen.
2. Bewahren Sie diese Anleitungen für den späteren Gebrauch gut auf.
3. Bitte treffen Sie alle beschriebenen Sicherheitsvorkehrungen.
4. Befolgen Sie die Anleitungen des Herstellers.
5. Benutzen Sie das Gerät nicht in der Nähe von Wasser oder Feuchtigkeit.
6. Verwenden Sie zur Reinigung des Geräts nur ein feuchtes Tuch.
7. Blockieren Sie keine Belüftungsöffnungen. Nehmen Sie den Einbau des Geräts nur entsprechend den Anweisungen des Herstellers vor.
8. Bauen Sie das Gerät nicht in der Nähe von Wärmequellen wie Heizkörpern, Wärmeklappen, Öfen oder anderen Geräten (inklusive Verstärkern) ein, die Hitze erzeugen.
9. Setzen Sie die Sicherheitsfunktion des polarisierten oder geerdeten Steckers nicht außer Kraft. Ein polarisierter Stecker hat zwei flache, unterschiedlich breite Pole. Ein geerdeter Stecker hat zwei flache Pole und einen dritten Erdungsstift. Der breitere Pol oder der dritte Stift dient Ihrer Sicherheit. Wenn der vorhandene Stecker nicht in Ihre Steckdose passt, lassen Sie die veraltete Steckdose von einem Elektriker ersetzen.
10. Schützen Sie das Netzkabel dahingehend, dass niemand darüber laufen und es nicht geknickt werden kann. Achten Sie hierbei besonders auf Netzstecker, Mehrfachsteckdosen und den Kabelanschluss am Gerät.
11. Ziehen Sie den Netzstecker des Geräts bei Gewittern oder längeren Betriebspausen aus der Steckdose.
12. Überlassen Sie die Wartung qualifiziertem Fachpersonal. Eine Wartung ist notwendig, wenn das Gerät auf irgendeine Weise, beispielsweise am Kabel oder Netzstecker beschädigt wurde, oder wenn Flüssigkeiten oder Objekte in das Gerät gelangt sind, es Regen oder Feuchtigkeit ausgesetzt war, nicht mehr wie gewohnt betrieben werden kann oder fallen gelassen wurde.

ATTENTION: Pour éviter tout risque d'électrocution ou d'incendie, ne pas exposer cet appareil à la pluie ou à l'humidité. Pour éviter tout risque d'électrocution, ne pas ôter le couvercle ou le dos du boîtier. Cet appareil ne contient aucune pièce remplaçable par l'utilisateur. Confiez toutes les réparations à un personnel qualifié. Le signe avec un éclair dans un triangle prévient l'utilisateur de la présence d'une tension dangereuse et non isolée dans l'appareil. Cette tension constitue un risque d'électrocution. Le signe avec un point d'exclamation dans un triangle prévient l'utilisateur d'instructions importantes relatives à l'utilisation et à la maintenance du produit.

Consignes de sécurité importantes

1. Veuillez lire toutes les instructions avant d'utiliser l'appareil.
2. Conserver ces instructions pour toute lecture ultérieure.
3. Lisez avec attention toutes les consignes de sécurité.
4. Suivez les instructions du fabricant.
5. Ne pas utiliser cet appareil près d'une source liquide ou dans un lieu humide.
6. Nettoyez l'appareil uniquement avec un tissu humide.
7. Veillez à ne pas obstruer les fentes prévues pour la ventilation de l'appareil. Installez l'appareil selon les instructions du fabricant.
8. Ne pas installer près d'une source de chaleur (radiateurs, etc.) ou de tout équipement susceptible de générer de la chaleur (amplificateurs de puissance par exemple).
9. Ne pas retirer la terre du cordon secteur ou de la prise murale. Les fiches canadiennes avec polarisation (avec une lame plus large) ne doivent pas être modifiées. Si votre prise murale ne correspond pas au modèle fourni, consultez votre électricien.
10. Protégez le cordon secteur contre tous les dommages possibles (pincement, tension, torsion, etc.). Veillez à ce que le cordon secteur soit libre, en particulier à sa sortie du boîtier.
11. Déconnectez l'appareil du secteur en présence d'orage ou lors de périodes d'inutilisation prolongées.
12. Consultez un service de réparation qualifié pour tout dysfonctionnement (dommage sur le cordon secteur, baisse de performances, exposition à la pluie, projection liquide dans l'appareil, introduction d'un objet dans le boîtier, etc.).

PRECAUCION: Para reducir el riesgo de incendios o descargas, no permita que este aparato quede expuesto a la lluvia o la humedad. Para reducir el riesgo de descarga eléctrica, nunca quite la tapa ni el chasis. Dentro del aparato no hay piezas susceptibles de ser reparadas por el usuario. Dirija cualquier reparación al servicio técnico oficial. El símbolo del relámpago dentro del triángulo equilátero pretende advertir al usuario de la presencia de "voltajes peligrosos" no aislados dentro de la carcasa del producto, que pueden ser de la magnitud suficiente como para constituir un riesgo de descarga eléctrica a las personas. El símbolo de exclamación dentro del triángulo equilátero quiere advertirle de la existencia de importantes instrucciones de manejo y mantenimiento (reparaciones) en los documentos que se adjuntan con este aparato.

Instrucciones importantes de seguridad

1. Lea todo este manual de instrucciones antes de comenzar a usar la unidad.
2. Conserve estas instrucciones para cualquier consulta en el futuro.
3. Cumpla con todo lo indicado en las precauciones de seguridad.
4. Observe y siga todas las instrucciones del fabricante.
5. Nunca utilice este aparato cerca del agua o en lugares húmedos.
6. Limpie este aparato solo con un trapo suave y ligeramente humedecido.
7. No bloquee ninguna de las aberturas de ventilación. Instale este aparato de acuerdo a las instrucciones del fabricante.
8. No instale este aparato cerca de fuentes de calor como radiadores, calentadores, hornos u otros aparatos (incluyendo amplificadores) que produzcan calor.
9. No anule el sistema de seguridad del enchufe de tipo polarizado o con toma de tierra. Un enchufe polarizado tiene dos bornes, uno más ancho que el otro. Uno con toma de tierra tiene dos bornes normales y un tercero para la conexión a tierra. El borne ancho o el tercero se incluyen como medida de seguridad. Cuando el enchufe no encaje en su salida de corriente, llame a un electricista para que le cambie su salida anticuada.
10. Evite que el cable de corriente quede en una posición en la que pueda ser pisado o aplastado, especialmente en los enchufes, receptáculos y en el punto en el que salen de la unidad.
11. Desconecte de la corriente este aparato durante las tormentas eléctricas o cuando no lo vaya a usar durante un periodo de tiempo largo.
12. Dirija cualquier posible reparación solo al servicio técnico oficial. Deberá hacer que su aparato sea reparado cuando esté dañado de alguna forma, como si el cable de corriente o el enchufe están dañados, o si se han derramado líquidos o se ha introducido algún objeto dentro de la unidad, si esta ha quedado expuesta a la lluvia o la humedad, si no funciona normalmente o si ha caído al suelo.

Table of Contents

Introduction	2
MDR8 Features	3
Front and Rear Panel Layout	4
Front and Rear Panel Controls	5
Controls and Functions	
Mono Input Channel Section	6–7
Master Section	8–9
MDR8 Input and Output Connections	10–11
Operating the MDR8	12–16
System Set-ups	17–18
MDR8 Wiring Guide	19
Specifications	20
Block Diagram	21

THIS DEVICE COMPLIES WITH PART 15 OF THE FCC RULES CLASS B. OPERATION IS SUBJECT TO THE FOLLOWING TWO CONDITIONS: (1) THIS DEVICE MUST NOT CAUSE HARMFUL INTERFERENCE, AND (2) THIS DEVICE MUST ACCEPT ANY INTERFERENCE RECEIVED INCLUDING INTERFERENCE THAT MAY CAUSE UNDESIRE OPERATION. SUITABLE FOR HOME OR OFFICE USE.

Copyright 2003 - 2004, Samson Technologies Corp.

Printed March, 2004

Samson Technologies Corp.
575 Underhill Blvd.
P.O. Box 9031
Syosset, NY 11791-9031
Phone: 1-800-3-SAMSON (1-800-372-6766)
Fax: 516-364-3888
www.samsontech.com

Introduction

Congratulations on your purchase of the Samson MDR8 mixer! The MDR8 is an eight channel mixer, with six low noise microphone pre-amps, and built-in 24 BIT DSP effects processor. The MDR8 also features HDM (Hard Disk Mode), which when engaged, provides a special monitoring and bussing mode ideal for interfacing with a computer based hard disk recorder. Clean, clear sound reproduction with dazzling digital effects including Delay, Chorus and lush Reverb, packaged in a rugged enclosure, ensure reliable high quality sound from performance to performance. Optimized for recording, live sound reinforcement and commercial installations, the MDR8 is an ideal mixer solution offering big sound in a compact package.

In these pages, you'll find a detailed description of the features of the MDR8 mixer, as well a description of its front and rear panels, step-by-step instructions for its setup and use, and full specifications. You'll also find a warranty card enclosed—please don't forget to fill it out and mail it in so that you can receive online technical support and so we can send you updated information about these and other Samson products in the future.

With proper care and adequate air circulation, your MDR8 will operate trouble free for many years. We recommend you record your serial number in the space provided below for future reference.

Serial number: _____

Date of purchase: _____

Should your unit ever require servicing, a Return Authorization number (RA) must be obtained before shipping your unit to Samson. Without this number, the unit will not be accepted. Please call Samson at 1-800-3SAMSON (1-800-372-6766) for a Return Authorization number prior to shipping your unit. Please retain the original packing materials and if possible, return the unit in the original carton and packing materials.

MDR8 Features

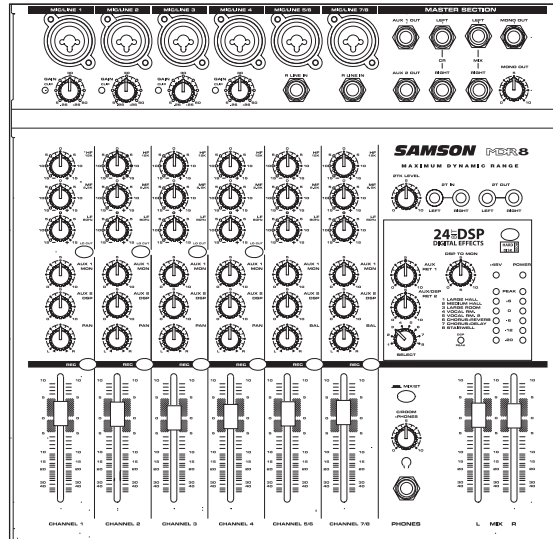

The Samson MDR8, eight channel mixer with onboard 24 BIT DSP is a comprehensive, all-in-one solution for live sound, recording, fixed installation and post production applications. Here are some of its main features:

- Eight Channels – Four Mic/Line plus two Stereo inputs with mic pre's.
- Flexible design topology ideal for live sound, recording and post production.
- On-board 24 BIT DSP (Digital Signal Processor) multi-effects processor with eight great sounding presets including REVERB, DELAY AND CHORUS.
- Unique monitoring and bussing in HDM (HARD DISK MODE) provides a seamless interface with computer based, hard disk recording systems.
- 60 mm audio taper faders on all channels and the master Mix outputs.
- 2T LEVEL control allows you to mix in a CD, DAT, Cassette, Computer Sound Card or Mini Disk with the channel faders.
- Three-band channel equalizer, +/-15dB at 80Hz, 2.5 KHz and 12KHz provides precise and musical results in sound shaping.
- Two Auxiliary Sends for built-in or external effects, on stage monitor mix, or headphone mixing.
- Five segment LED Meter with VU ballistics displays the main MIX output.
- High quality, low noise, discrete microphone pre-amplifiers with 48-Volt phantom power, provide Maximum Dynamic Range and transparent audio.
- Advanced circuit design using discrete components and high quality, low noise op-amps carefully selected at each stage of the signal path.
- Quality built and rugged construction ensure reliable performance from venue to venue and session to session.
- Three-year extended warranty.

Front and Rear Panel Layout

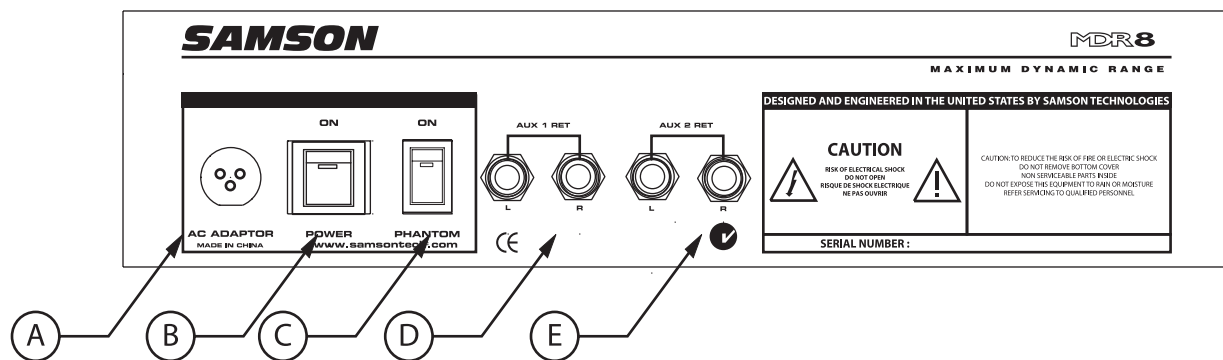
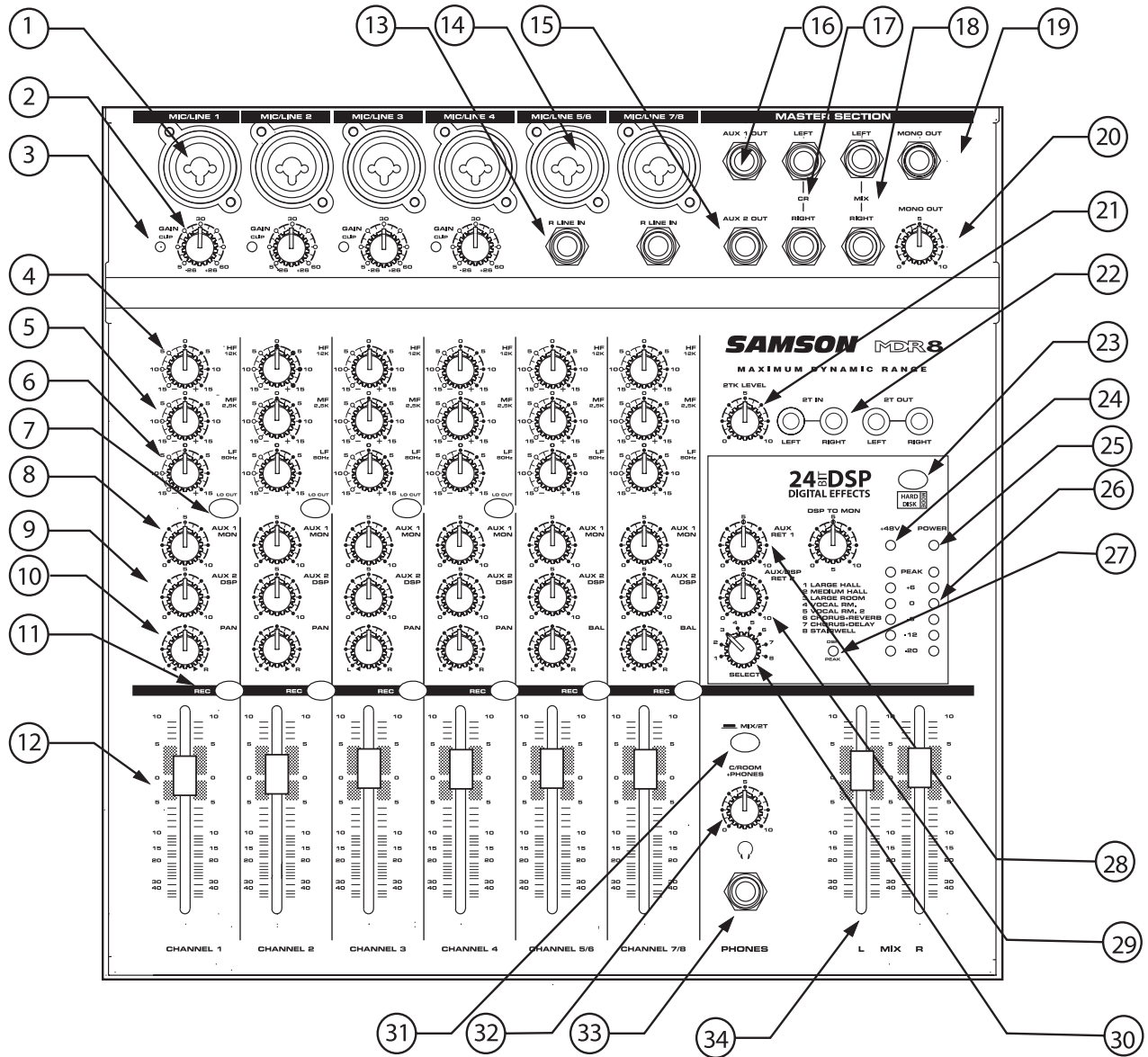

Front and Rear Panel Layout

FRONT PANEL

- ① **MIC/LINE** – Combination Input connector for Low-Noise Microphone pre-amp and Line level inputs.
- ② **GAIN** – Used to set the input level of the mic pre and line input.
- ③ **CLIP** – Red LED will illuminate indicating when the mic GAIN has been adjusted too high.
- ④ **HIGH FREQUENCY** - Controls the high band of the Channel Equalizer, +/- 15 dB at 12KHz.
- ⑤ **MID FREQUENCY** - Controls the mid band of the Channel Equalizer, +/- 15 dB at 2.5KHz.
- ⑥ **LOW FREQUENCY** - Controls the low band of the Channel Equalizer, +/- 15 dB at 80Hz.
- ⑦ **LOW CUT** – Bass roll off switch at 80Hz used to eliminate unwanted low end rumble and hum.
- ⑧ **AUX 1/MONITOR** – Pre fader auxiliary send that can be used with an external effects processor, or to create a cue or monitor mix.
- ⑨ **AUX 2/DSP** – Post fader auxiliary send connected to the internal 24 BIT DSP effect processor and can also be used with an external effects processor.
- ⑩ **PAN** – Controls the channel's balance between left and right in the stereo bus.
- ⑪ **RECORD** – Used in the HDM (HARD DISK MODE) to assign the channel to the Record bus.
- ⑫ **FADER** – 60 mm audio taper fader provides smooth control over level changes.
- ⑬ **STEREO RIGHT LINE** – Right Line Input connector on the stereo channels.
- ⑭ **STEREO MIC/LINE** - Combination Input connector for Low-Noise Microphone pre-amp and Left Line Inputs for the stereo channels.
- ⑮ **AUX 2**– Output connector for Auxiliary 2.
- ⑯ **AUX 1** - Output connector for Auxiliary 1.
- ⑰ **CONTROL ROOM** – Left and Right output connectors for connecting a monitor system.
- ⑱ **MIX** – Left and Right main Mix output connectors.
- ⑲ **MONO OUT** – The Left and Right main Mix outputs are summed together to a monaural signal and sent out this connector.
- ⑳ **MONO OUT LEVEL** – Used to set the volume of the MONO mix.
- ㉑ **2TK LEVEL (2T TO MIX)** - Level control used to mix the 2 track input.
- ㉒ **2 TRACK INPUTS & OUTPUTS** – Connect a DAT, Cassette, Mini Disk or Hard Disk Recording system.
- ㉓ **HDM (Hard Disk Mode)** - Switch configures the mixer for recording and overdubbing on a computer based hard disk recording system.
- ㉔ **PHANTOM** – Indicates that the 48 Volt Phantom Power is on.
- ㉕ **POWER** – Indicates the MDR8 is powered up.
- ㉖ **OUTPUT METER** - Five segment display with VU ballistics indicates main Mix level.
- ㉗ **DSP PEAK LED** - LED light illuminates when the signal sent to the internal DSP is clipped.
- ㉘ **AUX 1 RETURN** – Used to mix in level of the external effects.
- ㉙ **AUX 2 RETURN** – Used to mix in level of the internal DSP effects return.
- ㉚ **SELECT** - Used to switch between the 8 pre-sets of the internal DSP effects processor.
- ㉛ **2TRACK/MIX** – Switches between the main Mix and the 2 Track in the Control Room output.
- ㉜ **C ROOM/HEADPHONE** – Adjusts the volume of the control room speakers or headphones.
- ㉝ **HEADPHONE JACK** – Connect stereo headphones here.
- ㉞ **MIX FADERS**- Used to control the overall volume of the Left and Right main Mix outputs.

REAR PANEL

- Ⓐ **AC ADAPTER INLET** – Connect External AC power supply here.
- Ⓑ **POWER** – Switches on the MDR8's main power.
- Ⓒ **PHANTOM** – Engages the 48-Volt Phantom power supply to microphone pre- amps.
- Ⓓ **AUX 1 RETURN** – Connectors for stereo effects return.
- Ⓔ **AUX 2 RETURN** – Connectors for stereo effects return.

Controls and Functions

MONO INPUT CHANNEL SECTION

The following section details each part of the MDR8's MONO INPUT CHANNELS including the GAIN control, 3-BAND EQ, AUX sends, RECORD, PAN and LEVEL controls. The input channels one through four on the MDR8 feature high quality, discrete transistor pre-amp providing transparency and extended dynamic range. The combination connector accepts a standard XLR mic cable for microphone level signals, or a standard 1/4" phone cable, either balanced (TRS – TIP/ RING/SLEEVE) or unbalanced (TS – TIP/SLEEVE) for line level signals.

1 GAIN

The MDR8's pre-amp stage has a variable GAIN control with a range of 5 to 60dB on the MIC input and -26 to +26dB on the LINE input.

2 CLIP LED

The MDR8's MIC/LINE pre-amp also includes a CLIP LED which, when illuminated, indicates that the signal is peaking or overloading. To reduce distortion, lower the GAIN control to keep this LED from staying on.

3 CHANNEL EQUALIZER

The MDR8 input channels feature a 3-band equalizer allowing you to adjust the high, mid, and low frequencies independently on each channel. The channel's frequency response is flat when the knobs are in the "12:00" position. Rotating the knob towards the right will boost the corresponding frequency band by 15dB, and rotating it towards the left will cut the frequency by 15dB. The frequency centers, range of boost or cut, and equalizer type for each band are as follows:

High: 12KHz +/- 15dB shelving type

Mid: 2.5KHz +/- 15dB peaking type

Low: 80Hz +/- 15dB shelving type

4 LOW CUT FILTER

Each of the MDR8's channels include a LOW CUT (or high pass) filter which rolls off the low frequencies from 80Hz and below at the rate of 12dB per octave.

5 AUX 1/MON SEND

The MDR8 has two auxiliary sends which can be used for sending signals to the external effects devices or for creating a monitor mix. The AUX1/MON section is often used for a monitor mix in a live sound mixing, or for a headphone mix in a recording application. Each input channel includes an AUX 1/Mon send which controls the amount of that channel's signal that is sent to the AUX 1/Mon bus. The Input channel's AUX 2/Mon sends are mixed together and are sent to the AUX 1 OUT jack.

6 AUX 2 / DSP Send

The MDR8 provides high quality, 24 Bit digital effects, and the level of effects can be set independently on each channel. The channel's AUX 2/DSP knob controls the amount of signal that is sent to the AUX 2/DSP bus. The signal of the AUX 2/DSP bus is routed to the internal DSP effects section for onboard signal processing. The AUX 2/DSP signal can also be sent to an external effect device connected to the AUX 2 OUT jacks located in the MASTER SECTION jack field.

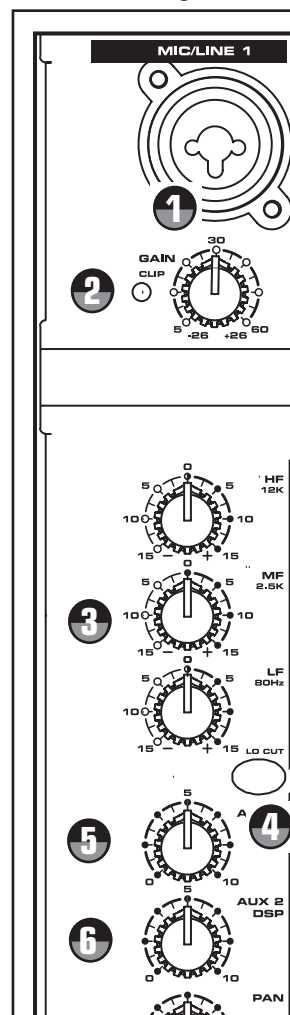

Controls and Functions

(MONO INPUT CHANNEL CONTINUED)

NOTE: The channel's AUX 2/DSP signal is sent to the AUX 2/DSP bus from a location in the signal path after the channel's LEVEL control. This is commonly referred to as a POST FADER send. This means that the amount of signal that is sent to the EFFECT bus will be affected not only by the setting of the AUX 2/DSP knob control, but it will also be affected by the setting of the LEVEL control.

7 BALANCE (Stereo Inputs Only)

The MDR8's BALANCE control is used to place or position the stereo signal into the main Left and Right MIX bus. You can move a stereo signal's image to the left or right by setting the BALANCE control to the left or to the right.

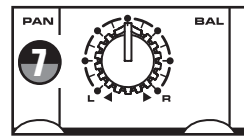

8 PAN (Mono Inputs Only)

The MDR8's PAN control is used to place or position the mono signal into the stereo main Left and Right MIX bus. You can create a stereo image by panning some input signals to the left and others to the right. The MDR8's PAN control is a Power-Pan circuit, which includes a 3dB dip in the center position. This is desirable since there's a 3dB increase in gain when the mono input signal is heard in both the Left and Right MIX bus.

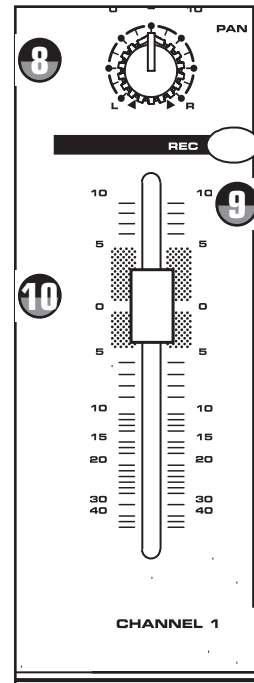

9 RECORD

The RECORD switch is used when operating the MDR8's HDM (HARD DISK MODE). If HDM in the master section is not engaged, the RECORD switch LED will be off and pressing the RECORD switch will have no effect. This is the normal mode of operation for most live mixing situations, however since the HDM provides some extra flexibility in signal routing, the HDM can be used for zone mixing as well. For more information on the HDM see the section "Using the HDM" on page 15 of this manual.

10 FADER

The MDR8's 60mm input FADER controls the overall channel level. The input FADER features an audio taper and no detents for smooth fades.

Controls and Functions

MASTER SECTION

2 TRACK INPUT AND OUTPUT

The MDR8's 2 Track section provides the connections for playback and recording for an external device such as a DAT, cassette recorder, CD or Mini Disk.

11 2TK LEVEL

The 2TK LEVEL control is used to adjust the amount of signal that is sent from the 2T IN jacks to the main L/R Mix bus. For more information see the section, "Playing back a CD Using the 2 Track to MIX" on page 15 of this manual.

12 HDM

The HDM switch enables the HARD DISK MODE and is used to interface with a computer based hard disk recorder. When turned on, the channel RECORD switches are activated for special bussing and monitoring features. For more information on using HDM, see the section "Using the HDM" on page 15 of this manual.

24 BIT DIGITAL EFFECT SECTION

The MDR8 features a built-in, 24 Bit Digital Effects processor with high quality, studio grade effects such as Delay, Chorus and Reverb. The following section describes the features of the powerful on-board DSP.

13 SELECT Switch (DIGITAL EFFECTS)

The SELECT switch allows you to select one of the eight built-in digital effects. Simply rotate the SELECT knob to choose the various effect pre-sets.

14 DSP PEAK

The DSP PEAK indicator lets you know when you are sending too much level to the internal effects processors. If the LED illuminates, turn down the signal from the channel's AUX 2 /DSP send. You may need to do this on more than one channel if you have multiple inputs sending to the internal DSP.

15 DSP TO MON

The DSP TO MON allows you to add the internal effects to the AUX 1/ MON send. When you raise the level of the DSP TO MON control, the signal from the DSP return is mixed in to the AUX 1/ MON. You can use this to add effects to your monitor mix in a live sound mix or to your headphone mix in the studio.

16 Effect Preset List

This section identifies the eight built-in DSP effects presets. Following is the effects pre-set list:

- 1 LARGE HALL
- 2 MEDIUM HALL
- 3 LARGE ROOM
- 4 VOCAL RM.
- 5 VOCAL RM. 2
- 6 CHORUS+REVERB
- 7 CHORUS+DELAY
- 8 STAIRWELL

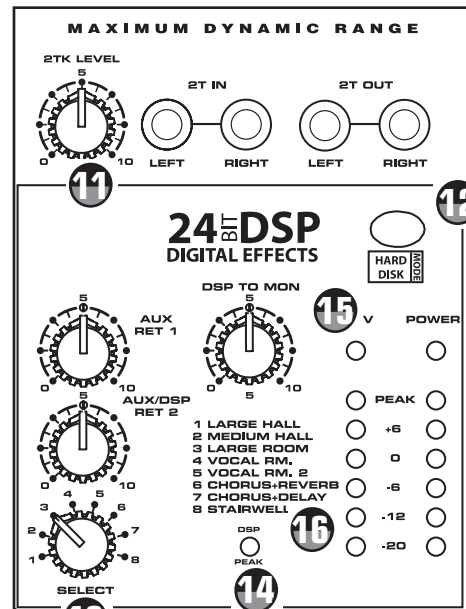

MDR8 Input and Output Connections

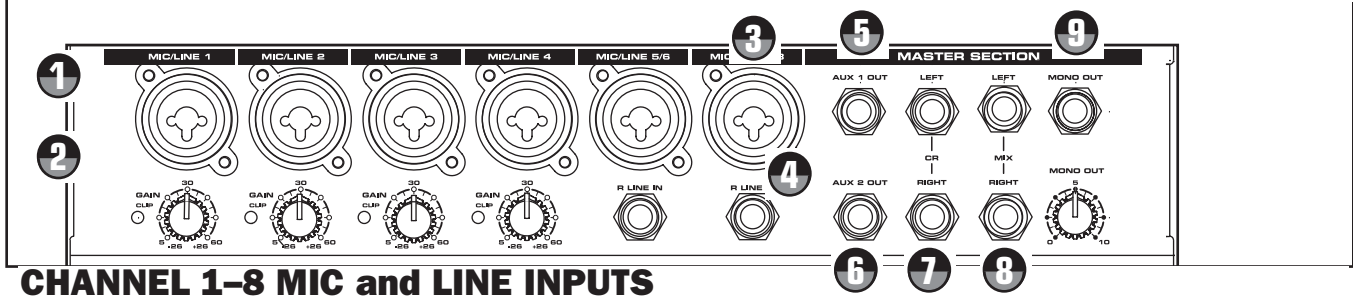

CHANNEL 1-8 MIC and LINE INPUTS

The MDR8's eight input channels each have a "Combie" (combination XLR & 1/4-inch) connector with a LINE level, Hi-Z (High Impedance) input and a MIC level, Low-Z (Low Impedance) input. By using the GAIN control on channels 1-4 you can connect a variety of signal sources from microphones and direct boxes to line level devices such as synthesizers and drum machines. All the LINE and MIC inputs are balanced. The MIC inputs are compatible with microphones with output impedances of 50~600 Ohms and the LINE inputs are compatible with line level devices of 600 Ohms.

NOTE: It is not possible to simultaneously use both the LINE and MIC inputs on the same channel (with the exception on the stereo input channels). Use only one of the inputs for the appropriate source for each channel.

Following below is a detailed description of the MDR8's input and output connectors.

1 Line Level Input - Mono Input Channels

Use these inputs to connect line level signal from synthesizers, drum machines, effects processors or any line-level signal. The LINE inputs have a nominal operating level of -40dB through -10dB. TRS phone jacks (located in the center of the combie connector). Connector pin-out - Sleeve: Ground, Tip: Hot (+), Ring: Cold (-)

2 Microphone Input - Mono Input Channels

Use these inputs to connect Low Impedance microphones and low level signals from direct boxes. The MIC inputs have a nominal operating level of -50dB through -20dB. The MIC inputs also feature +48V phantom power, allowing you to use condenser microphones. The Phantom Power switch located on the MDR8's rear panel enables phantom power on all the microphone inputs when set to the ON position. XLR Connector pin-out - Pin 1: Ground, Pin 2: Hot (+), Pin 3: Cold (-)

3 Line Level Input - Stereo Input Channels

The MDR8's stereo channels have a stereo LINE input with the Left Input located in the center of the Combie connector and a separate 1/4-inch connector for the Right Input. You can connect the outputs from stereo devices such as synthesizers, drum machines, effects processors or any stereo line-level signal. The LINE inputs have a nominal operating level of -40dB through -10dB. TRS phone jacks Connector pin-out - Sleeve: Ground, Tip: Hot (+), Ring: Cold (-)

4 Microphone Input - Stereo Input Channels

The MDR8's stereo channels have a utility MIC input located on the Combie connector. The utility MIC inputs have a nominal operating level of -50dB through -20dB. The MIC inputs also feature +48V phantom power, allowing you to use condenser microphones. The Phantom Power switch located on the MDR8's rear panel enables phantom power on all the microphone inputs when set to the ON position. XLR Connector pin-out - Pin 1: Ground, Pin 2: Hot (+), Pin 3: Cold (-)

MDR8 Input and Output Connections

EXTERNAL OUTPUT JACKS

The MDR8 features several output connectors allowing you to interface a variety of external devices. A stereo recording device such as a cassette recorder can be connected to the 2 Track jacks, and additional power amplifiers can be connected to the CONTROL ROOM and MAIN output jacks.

5 AUX 1 Output

The signal present at the AUX 1 output is sent from the AUX 1/ MON bus, which is fed from the AUX 1/ MON send on the input channels. The AUX 1 output can be used as the MONITOR MIX bus in a live sound situation by connecting the output to a power amp and monitor speaker.

6 AUX 2 OUTPUT

The AUX 2 output is used to send a signal to an external signal processor such as a delay or reverb. The signal present at the AUX 2 output is sent from the AUX2/DSP bus, which is fed from the AUX2/DSP send on the input channels.

7 CONTROL ROOM LEFT/RIGHT

The Control Room outputs are used to connect a studio monitor system. The Control Room outputs have the same output as the L/R MIX, however, the level can be adjusted independently from the main mix using the C ROOM/HEADPHONES control.

8 LEFT/RIGHT MIX

In a live sound application the LEFT/ RIGHT MIX outputs are connected to a power amplifier or powered speakers. In a recording application, the LEFT/ RIGHT MIX outputs are used to connect a stereo device such as computer sound card, DAT, or cassette recorder.

9 MONO OUTPUT

The Left and Right Mix outputs are summed together and sent to the MONO output. The level of the Mono signal can be adjusted using the MONO OUT level control located just below the connector and used to feed a speaker zone in a fixed installation.

10 AUX 1 RETURN LEFT/RIGHT

The AUX 1 RETURN LEFT/RIGHT are stereo inputs that are generally used to connect the outputs of an effects processor, but can also accept the signal from any line level source like a keyboard, recorder and even another mixer. The signal connected to the AUX 1 RETURN LEFT/RIGHT will feed the main LEFT/RIGHT MIX bus.

The overall level is controlled by the AUX 1 RET knob located in the master section on the front panel.

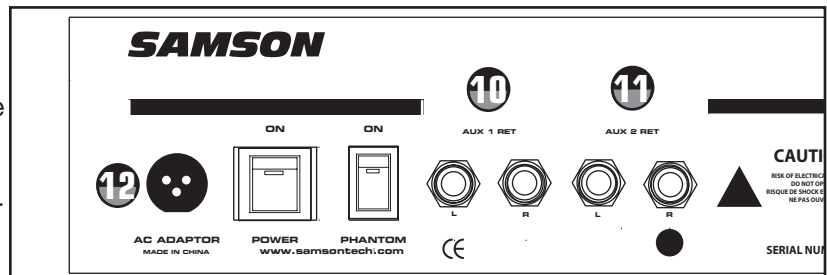

11 AUX 2 RETURN LEFT/RIGHT

The AUX 2 RETURN LEFT/RIGHT are stereo inputs that are generally used to connect the outputs of an effects processor, but can also accept the signal from any line level source like a keyboard, recorder and even another mixer. The signal connected to the AUX 2 RETURN LEFT/RIGHT will feed the main LEFT/RIGHT MIX bus. The overall level is controlled by the AUX 2 RET knob located in the master section on the front panel.

12 AC INLET

Connected the supplied Samson AC adapter here. Before connecting the supply, make sure that the MDR8 POWER and PHANTOM POWER switches are in the off position.

Operating the MDR8

BASIC OPERATION

The following section explains the basic operation of the MDR8.

CONNECTING MICROPHONES AND INSTRUMENTS

1. Before connecting mics or instruments, make sure that the power of all your systems components including the MDR8 is turned off. Also, make sure that the Left and Right MIX faders are turned all the way down.
2. Connect the cables to your microphones and instruments, and insert the other end of the cable firmly into the appropriate input on the MDR8.

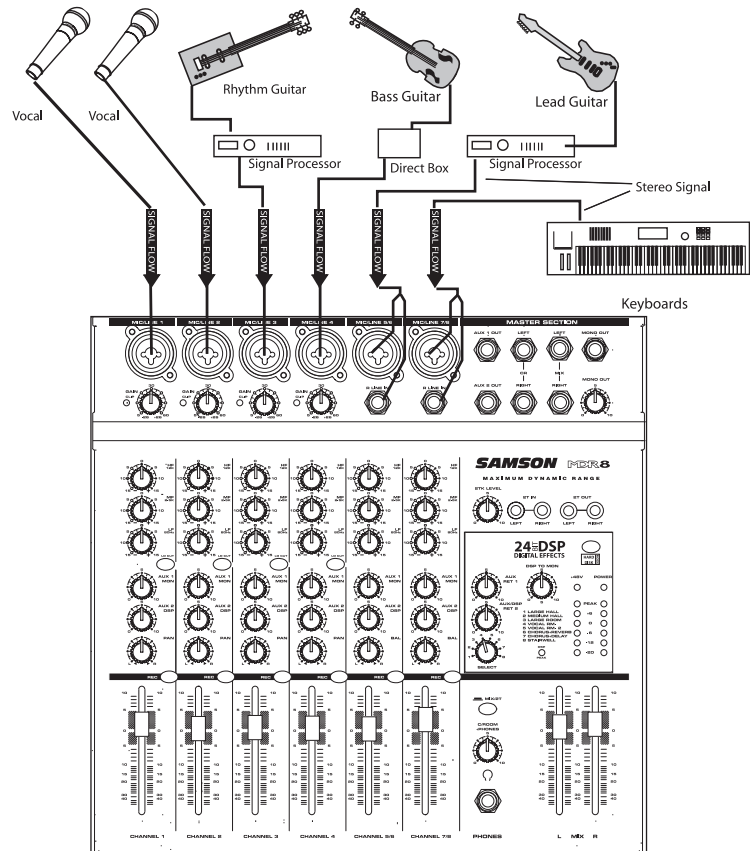

NOTE: SETTING THE INPUT GAIN - When connecting a microphone to channels 1 through 4, it's a good idea to start with the Gain Control turned all the way down. Set the input fader to the "0" position and slowly raise the GAIN control until you see the CLIP LED turn on. Now, back the GAIN control down so that the CLIP LED only lights for a short time during the loudest input the channel will see.

3. Switch on the power of any peripheral devices, and then power up the MDR8.

NOTE: It is important to remember the Golden Rule of audio ... "**LAST ON, FIRST OFF**". Translated, this means that when turning on your system, you should always turn your power amplifiers or powered monitors on **LAST**, and when turning your system off, turn your power amps off **FIRST**. This helps avoid any loud pops caused by rush current at power up, which can sometimes damage loudspeakers.

4. Turn on your power amp or powered monitors and raise the level control to the manufacturers' recommended operating level.
5. Set the Left and Right MIX faders in the MDR8's master section to the "0" position.
6. While speaking into the mic (or playing the instrument), adjust the channel Fader control so that the "0" LED of the MAIN section peak level meter lights occasionally.
7. You can shape the tone of each channel by adjusting the equalizer controls as desired.

Operating the MDR8

USING THE DIGITAL EFFECTS

The MDR8 features a built-in, high quality, 24 BIT Digital Signal Processor offering studio grade effects. The DSP features clean Delay, lush Reverbs and multi-effects such as Chorus + Delay or Chorus + Reverb. The following details the operation of the internal DSP effects:

1. Connect a mic or instrument to the desired channel, and adjust the volume and equalizer to your liking.
2. Now select the desired preset on the DSP selection switch. Set the DSP selection switch to one of the following effects:

- 1 - Large Hall
- 2 - Medium Hall
- 3 - Large Room
- 4 - Vocal Room
- 5 - Vocal Room 2
- 6 - Chorus + Reverb
- 7 - Chorus + Delay
- 8 - Stairwell

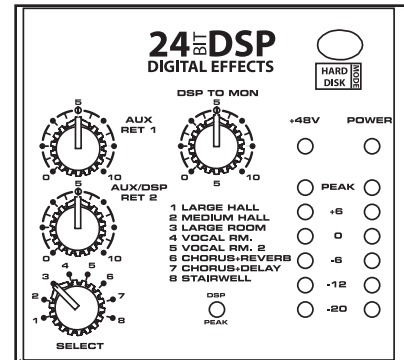

4. Once you have selected the desired effect preset, raise the AUX 2/DSP control on the channels you wish to apply the digital effect to.
5. Now use the AUX/DSP RTN 2 knob in the master section to adjust the effects return level. The EFX control is the overall level control for the DSP effects processor.

NOTE: If the effect sound is distorted even though the AUX/DSP RTN 2 is turned down low, lower the AUX2/DSP controls of each channel.

SENDING AN INDEPENDENT MIX TO THE MONITOR SPEAKERS

The MDR8's AUX1/MON auxiliary send can be used to feed a separate set of amplifiers and loudspeakers for stage monitors. This lets you build one stereo mix for the amplifiers and speakers facing the audience and the other mono mix for the amplifiers and monitor speakers facing the musicians.

1. Raise the AUX1/MON controls for the channels that you wish to hear from the monitor speakers.

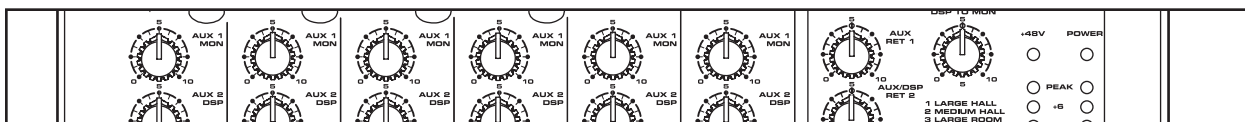

NOTE: The AUX1/MON controls are "PRE-FADER SENDS" which means they are not affected by the FADER level settings of each channel. This allows you to create a mix for the monitors that is independent of the main LEFT and RIGHT MIX.

2. In order to get the most gain from your monitor mix, use an external graphic equalizer like a Samson e311 to cut out any frequencies that cause feedback.

Operating the MDR8

USING AN EXTERNAL EFFECT

If you prefer to use an external device for effects processing, you can easily connect the unit using the MDR8 EFX bus disconnecting the internal DSP. Follow the simple steps below to interface your processor:

1. Connect the AUX 2 OUTPUT to the input of the external effect processor.
2. Connect the outputs of the effect processor to the AUX 2 RETURN located on the MDR8's rear panel.
3. Set the L/R mix faders to the "0" position.
4. Raise the AUX 2/DSP knobs for the channels to which you want the external effect to be applied.
5. Set the input level of the external effect so that the sound is not distorted and so that the effect's input meter does not indicate a clipped signal.
6. Use the AUX/DSP RET 2 control to adjust the level of the effects processed by the external effects device.

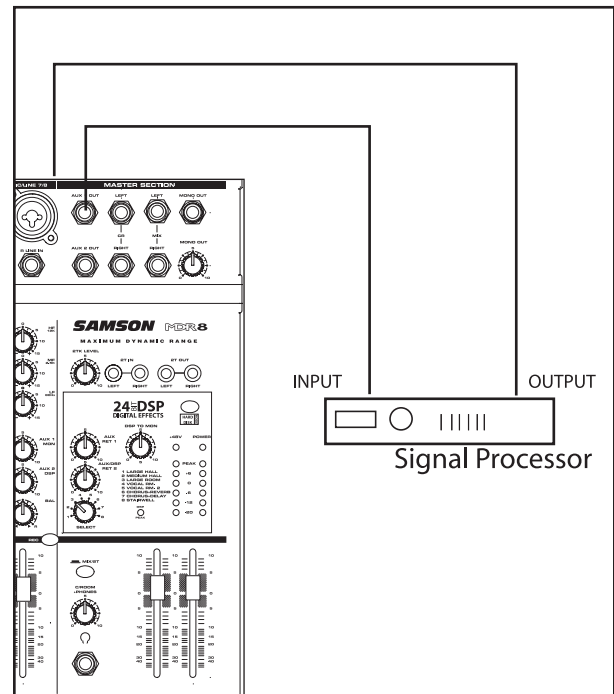

PLAYING BACK A CD USING 2TK LEVEL

The MDR8 has a dedicated input for playing back a stereo device such as a CD, Tape or Mini Disk. Below is a description of how you can play back a CD, Tape or MD using the MDR8's 2 TRACK INPUT.

1. Turn the 2TK LEVEL control and the LEFT / RIGHT MIX level control all the way down.
2. Press the MIX/2T button down.
3. Adjust the LEFT / RIGHT MIX faders in the master section to the "0" position.
4. Start playback on the CD, Tape or MD player, and use the 2T to MIX control to set the desired level.

RECORDING A MIX FROM THE MDR8

You can record the audio from the MDR8's mixer section including the MIC, LINE, TAPE IN and AUX inputs to a Cassette deck, MD, DAT or any other type of recorder using the RECORD outputs. Simply connect the MDR8's 2 TRACK OUT to the input jacks of the recorder as shown in the diagram on the right and follow the steps below.

1. Adjust the LEFT / RIGHT MIX faders in the master section to the "0" position.
2. Set a clean signal using the recorder's input level controls and meters.
3. Press RECORD.
4. Play back using as described in the previous section "PLAYING BACK A CD USING 2T TO MIX".

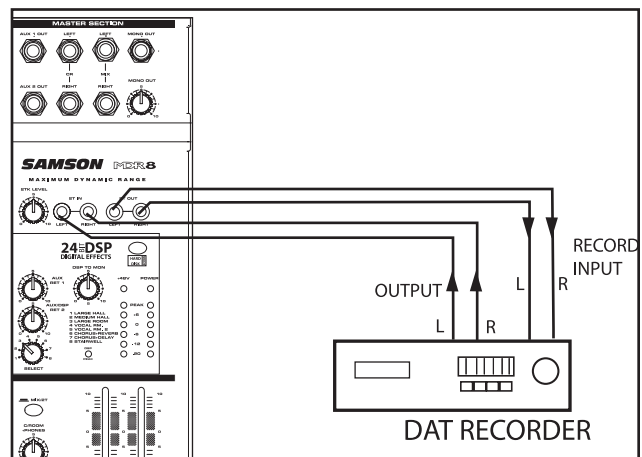

Operating the MDR8

Mixing a 2-track with the Stereo Mix

You can mix the 2T IN with the input faders using the Hard Disk Mode. To do this follow these simple steps.

- Connect the 2-track device to the 2T IN input connectors and any mic or line inputs to channels 1-8.
- In this mode the C/ROOM+PHONES control will act as your master volume, so for now, turn that all the way down.
- Connect the CR LEFT and RIGHT outputs to your power amp or powered speakers.
- Press the HDM switch in the master section so that the yellow LED is illuminated.
- Now raise the C/ROOM+PHONES level control up to a bit under 5.
- Raise the MASTER FADERS to “O” so you can hear the mix from the input channels 1 – 8.
- Now, raise the channel faders and 2TK LEVEL control until you have the mix you want.
- Adjust the C/ROOM+PHONES level control to set the desired final level.

Using The HDM (HARD DISK MODE)

The MDR8 includes an exclusive HDM (HARD DISK MODE) that has been designed to interface with computer based hard disk recorders. Never before have such flexible routing and monitoring been included in such a small mixer. The HDM provides a seamless solution for recording and over-dubbing on a hard disk recorder by providing a special record bus plus unique monitoring to solve latency problems.

When you are working with the mixer configured to HDM, the MDR8 engages the RECORD bus and a special 2-Track listening mode. When engaged, the HDM allows you to assign any of the channels to the RECORD bus. In this mode, the 2Track output (located in the Master section) is now outputting the mix from the RECORD bus. While in HDM you can still mix in the 2Track return, however, it will not be recorded since it is not sent to the RECORD (2Track Out) bus. Therefore, if your hard disk recorder is connected to the 2Track Inputs and Outputs, you can listen to the output of the hard disk recorder while listening to the MDR8 input channels. By listening to the tracks that you are recording directly from the input faders, you avoid having to loop back the track you are recording, thereby eliminating latency delays. Follow the examples below to use the HDM.

Set the MDR8 inputs fader all the way down and the L & R MIX faders to the “0” position. For this example, we’ll first record a rhythm track sequence from a MIDI keyboard (any stereo track will do), then do an overdub. If you are using an imported loop or internal sequencer, skip the Recording section and go on to the Overdub section.

Recording Using HDM

1. Connect the output from your computer sound card to the MDR8’s 2Track In and then connect the MDR8’s 2Track Output to the input of the sound card.
2. Connect the outputs from a MIDI keyboard to the stereo inputs channels 7/8.

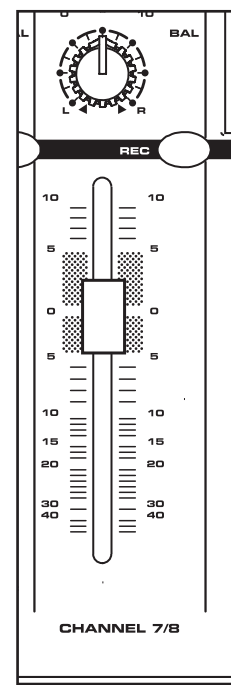
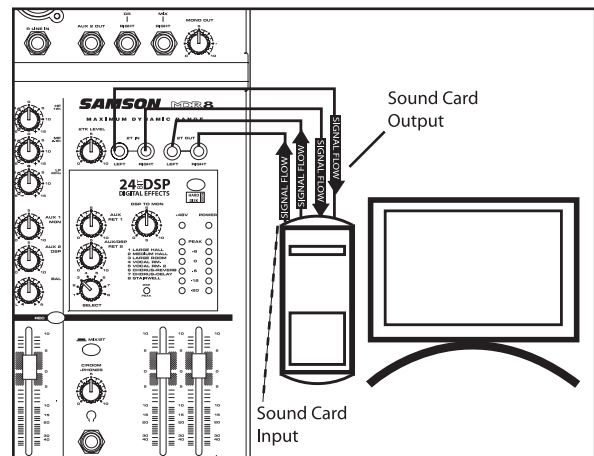

Operating the MDR8

Using The HDM (HARD DISK MODE) Continued

- Engage the HDM switch in the Master Section. The input channel's REC LED will light dimly indicating the channel can be assigned to the RECORD bus.
- Press the RECORD switch on the MDR8's channel 7/8. The input channel's REC LED will flash indicating the channel is assigned to the RECORD bus.
- Raise the channel 7/8 fader to the nominal area (0).
- Now, test your listening level by starting the MIDI sequencer and slowly raising the Control Room output level until you have set a comfortable listening level. If the sound is too low, raise the output level of your keyboard. If the sound is distorted, lower the output level of your keyboard.
- Select the record enable on the tracks you are recording to on your hard disk recorder and set a level as described in your software manual.
- Press REC/PLAY on your recorder and play on the MIDI sequencer.

Overdubbing Using HDM

Now that you have recorded a basic rhythm track you can overdub additional tracks using MDR8's HDM. For this example, we'll overdub a vocal track using a microphone. Follow the steps below.

- Connect the output from your computer sound card to the MDR8's 2Track In and then connect the MDR8's 2Track Output to the input of the sound card.
- Connect a microphone to the MDR8's Channel 1 microphone input and set a proper level using the GAIN control and peak LED.
- Engage the HDM switch. The input Channel's REC LED will light dimly indicating the channel can be assigned to the RECORD bus.
- Press the RECORD switch on the MDR8's channel 1. The input channel's REC LED will flash indicating the channel is assigned to the RECORD bus.
- Raise the Channel 1 fader to the nominal area (0).
- Now, test your listening level by pressing PLAY on your hard disk recorder and by slowly raising the 2TK LEVEL control until you have set a comfortable listening level. Use the 2TK LEVEL and CONTROL ROOM/HEADPHONE level controls to set a good balance between the hard disk recorder and the input.
- Select the record enable on the track you are recording to on your hard disk recorder and set a level as described in your software manual.
- Press REC/PLAY on your hard disk recorder and record your vocal track.

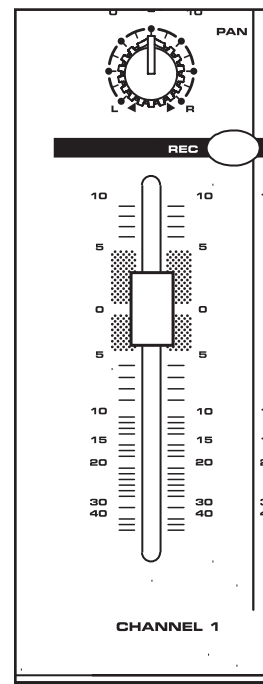

NOTE: The RECORD bus is stereo, therefore the input channels PAN and BALANCE controls will determine how much signal is sent to the LEFT or RIGHT 2 TRACK output. If you want an input channel's signal to send only to the LEFT RECORD bus, then set the PAN control all the way to the left. If you want an input channels signal to send only to the RIGHT RECORD bus, then set the PAN control all the way to the right.

MDR8 System Set-Ups

MDR8 LIVE SOUND SET-UP

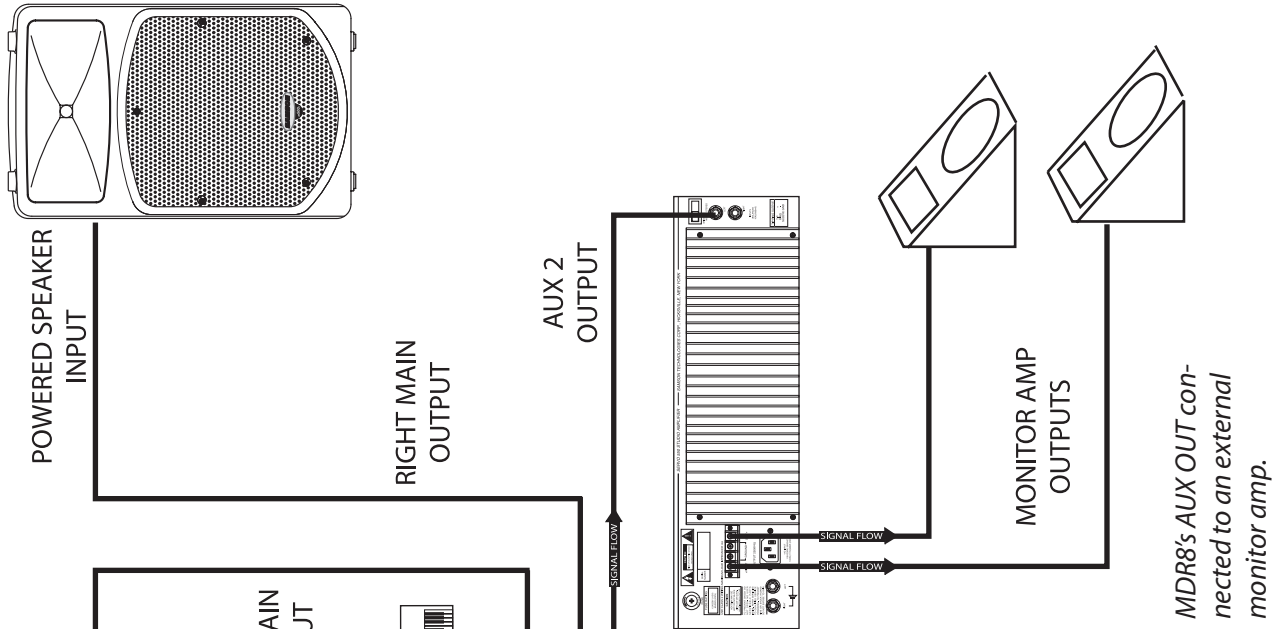

POWERED SPEAKER INPUT

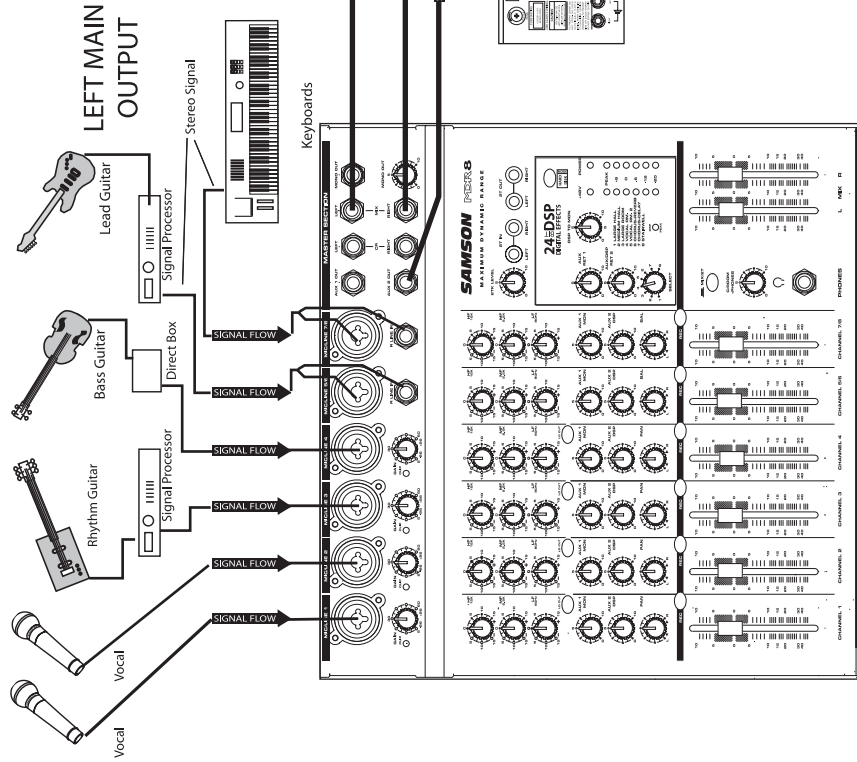
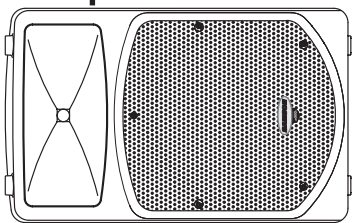

This system shows the MDR8 connected to a pair of powered speakers like the SAMSON Expedition EX20. The MONITOR OUT is connected to an external power amp, which is driving 2 monitor speakers. For inputs, two microphones are connected to channels 1 and 2's low-impedance inputs, and the output of the Bass Direct Box is also connected to the low-impedance input on channel 4. The Keyboards, as well as the Lead and Rhythm Guitar signal processor's outputs, are connected to the MDR8's line inputs.

MONITOR AMP OUTPUTS

MDR8's AUX OUT connected to an external monitor amp.

MDR8 System Set-Ups

MDR8 RECORDING SET-UP

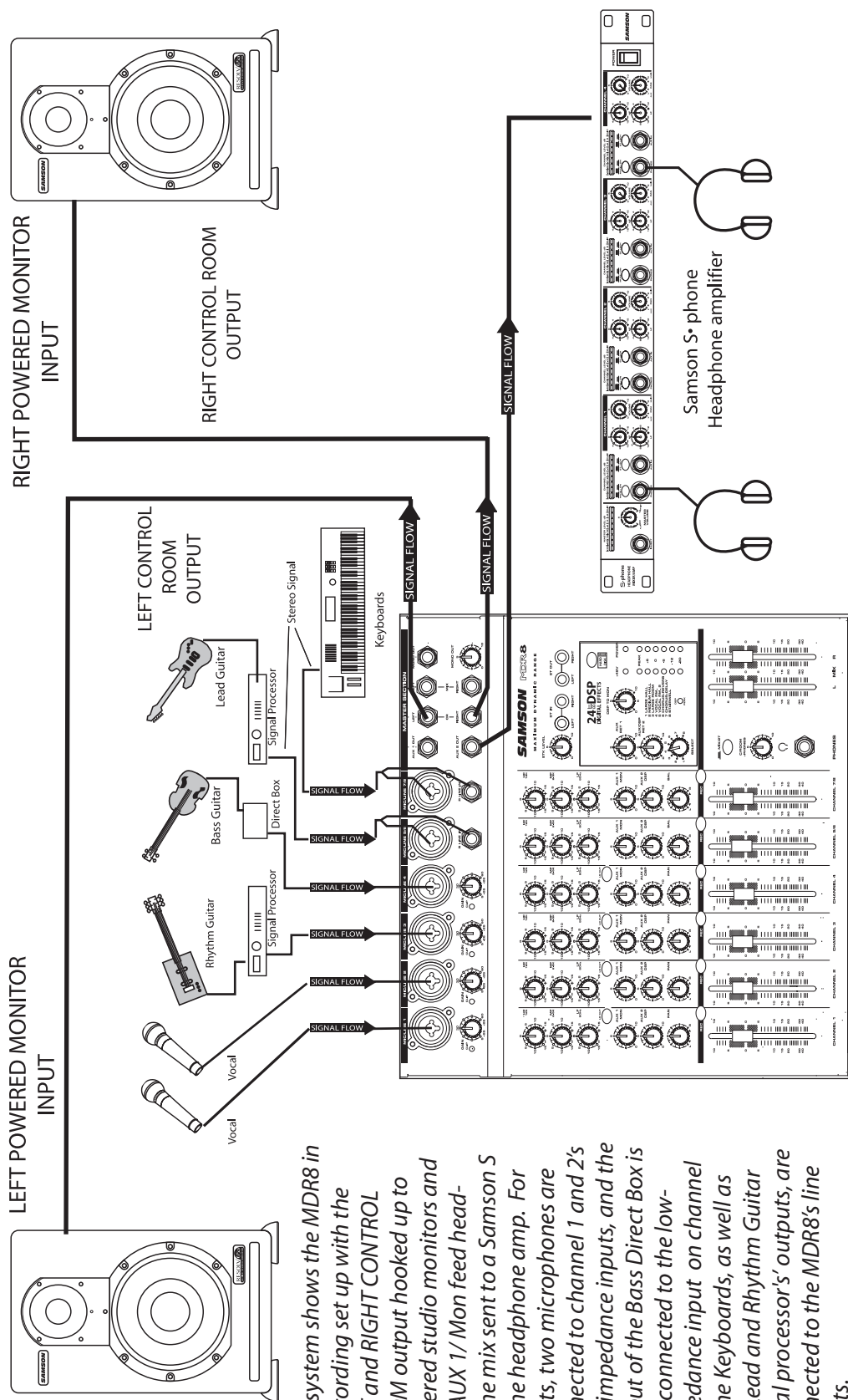

This system shows the MDR8 in a recording set up with the LEFT and RIGHT CONTROL ROOM output hooked up to powered studio monitors and the AUX 1/ Mon feed headphone mix sent to a Samson S* phone headphone amp. For inputs, two microphones are connected to channel 1 and 2's low-impedance inputs, and the output of the Bass Direct Box is also connected to the low-impedance input on channel 4. The Keyboards, as well as the Lead and Rhythm Guitar signal processor's outputs, are connected to the MDR8's line inputs.

MDR8 Wiring Guide

CONNECTING THE MDR8

There are several ways to interface the MDR8 to support a variety of applications. The MDR8 features balanced inputs and outputs, so connecting balanced and unbalanced signals is possible.

Unbalanced 1/4" Connector

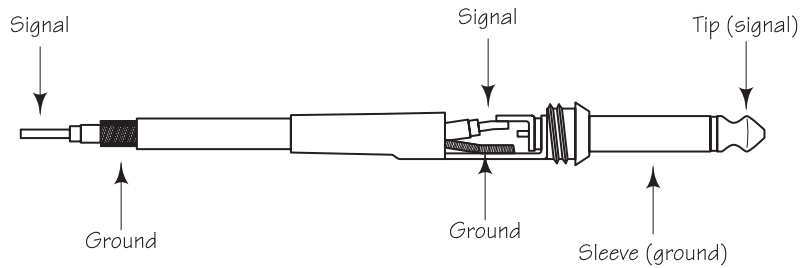

Balanced TRS 1/4" Connector

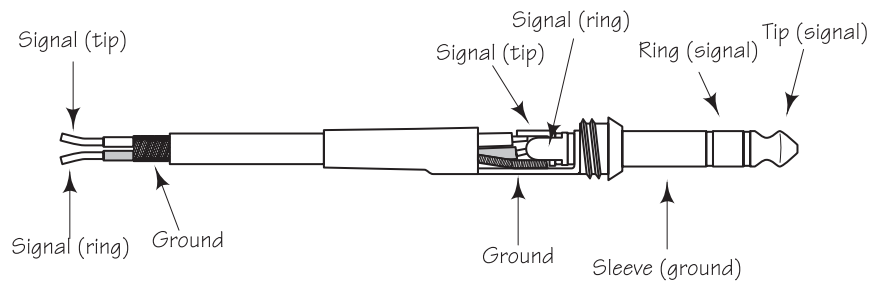

XLR Balanced Wiring Guide

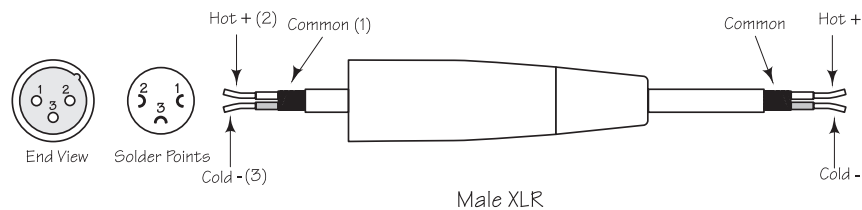
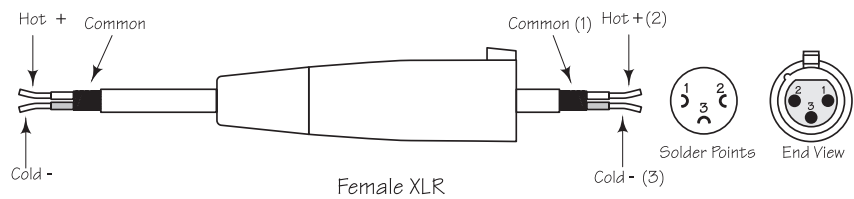

MDR8 Specifications

Frequency Response (Trim @ Min, unity gain \pm 3 dB)

Mic to Main	5 Hz - 54 kHz
Line to Main	5 Hz - 54 kHz
Aux Return to Main	5 Hz - 98 kHz
Line to Aux Send	5 Hz - 57 kHz

T.H.D. (Trim @ Min, +4dBu output, unity gain, 1 kHz w/30 kHz LPF)

Mic/Line to Main (Mono Ch)	0.02%
Line to Main (Stereo Ch)	0.02%
Line to Aux Send	0.02%

Equivalent Input Noise ("A" filter on, input shorted)

Mic	-128 dB
Line	-104 dB

Maximum Voltage Gain

Mic to Main	74 dB
Line to Main (Mono Ch)	56 dB
Line/Tape to Main (Stereo Ch)	34 dB
Aux Return to Main	20 dB
Mic to Aux Send	74 dB
Line to Aux Send (Stereo Ch)	34 dB

Residual Noise (30 kHz LPF, all control Min)

Main	-89 dBu
Aux Send	-86 dBu

Crosstalk (@ 1 kHz w/ 30 kHz LPF)

Ch vs. Ch	75 dB
Input vs. Output	87.5 dB

Peak LED Sensitivity (before clipping)

5 dB

CLIP Indicators

Turn on: THD > 0.1%

Headphone output (600 ohm load)

100 mW

Maximum Input Level (1 kHz, \pm 3dB)

Mic Input (Mono Ch)	10.5 dBu
Line Input (Stereo Ch)	7.6 dBu

Input Channel Equalizer (\pm 2dB)

High (shelving)	12 kHz \pm 15 dB
Mid (peaking)	2.5 kHz \pm 15 dB
Low (shelving)	80 Hz \pm 15 dB

Meters

6 POINT LED METERS (-20, -12, -6, 0, +6dB and PEAK)

Internal DSP Effects

24 BIT -8 presets: 1 - Large Hall; 2 Medium Hall, 3 - Large Room; 4 - Vocal Room 1; 5 - Vocal Room 2; 6 - Chorus + Reverb; 7 - Chorus + Delay; 8 - Stairwell

Phantom Power

+48V

Power Requirement

110V-240V, 50/60Hz

Power Consumption

24W

Dimensions (W x D x H)

11 1/2" x 11 1/2" x 3 1/2"
292mm x 292mm x 89mm

Weight

6.3 lbs. (2.9 Kg)

Block Diagram

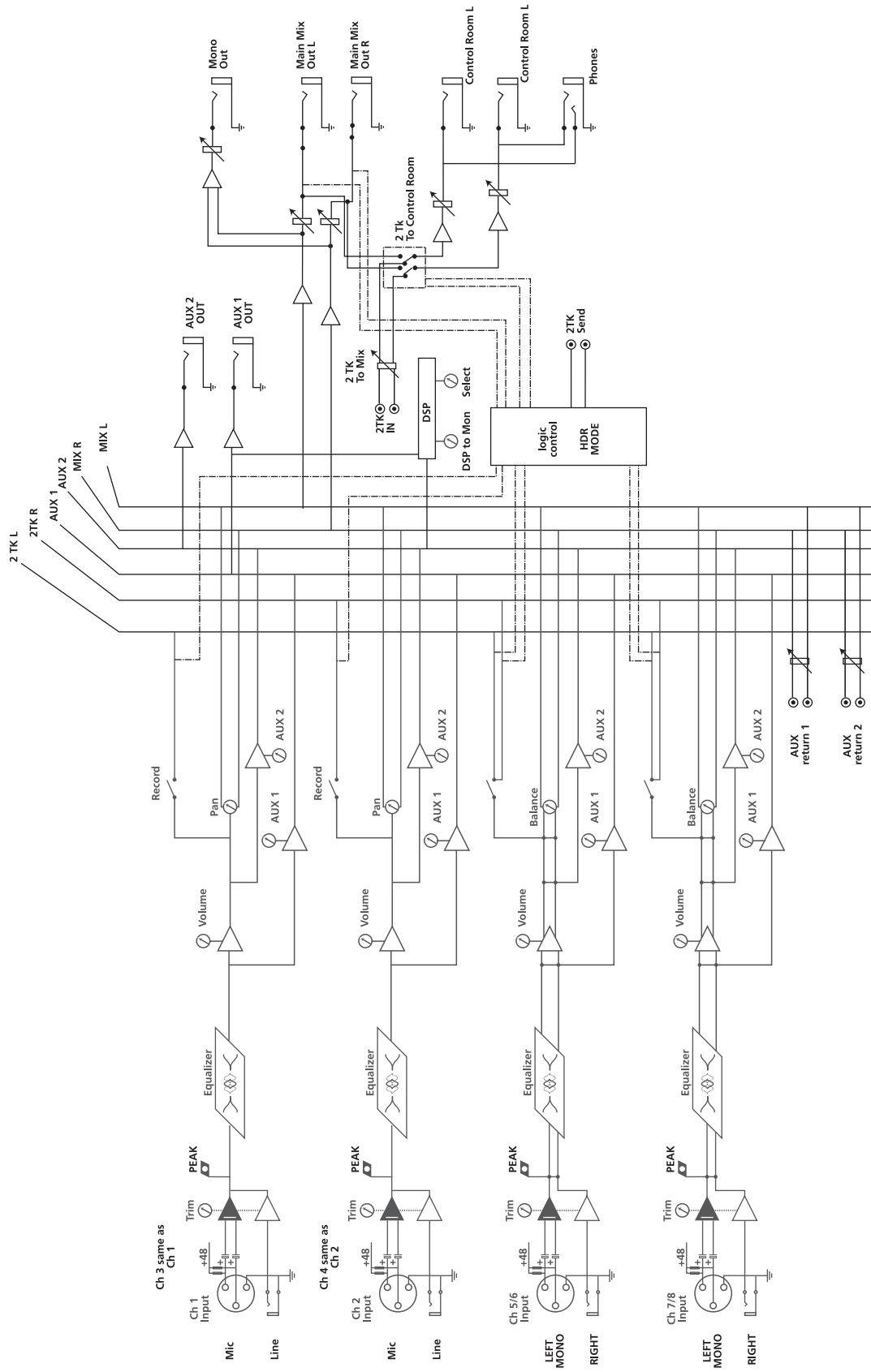

Samson Technologies Corp.
575 Underhill Blvd.
P.O. Box 9031
Syosset, NY 11791-9031
Phone: 1-800-3-SAMSON (1-800-372-6766)
Fax: 516-364-3888
www.samsontech.com